

Input data

System of measurement		Metric
Input type		Coupling for electric motor
Input speed	[rpm]	1400
Output speed	[rpm]	280
Ratio (i=)		5
Frequency	[Hz]	50
Input options		IEC
Requested input power	[kW]	0.25
Service factor		10.8
Rated Power P1	[kW]	2.7

Output data

Gear unit	F RT 50 B3 5 71 B5 AC 25	
------------------	---------------------------------	--

Type		RT - Worm speed reducers
Input type		F (Elastic coupling)
Size		50
Ratio (i=)		5
Input flange		B5
Input speed	[rpm]	1400
Output speed	[rpm]	280
Rated output torque	[Nm]	7.5
Service Factor		10.8
Efficiency		0.88

Gear unit configuration

Output shaft		Hollow output shaft
Fixing		Universal
Version		B3

Output radial and axial loads

Ball bearings output radial load	[N]	1450
Taper bearings output radial load	[N]	2000
Ball bearings output axial load	[N]	290
Taper bearings output axial load	[N]	400

Accessories

Hollow output shaft		AC 25
---------------------	--	-------

Electric motor coupling

Size		71 A4
Poles n.		4
Power	[kW]	0.25

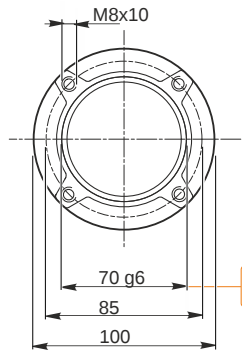
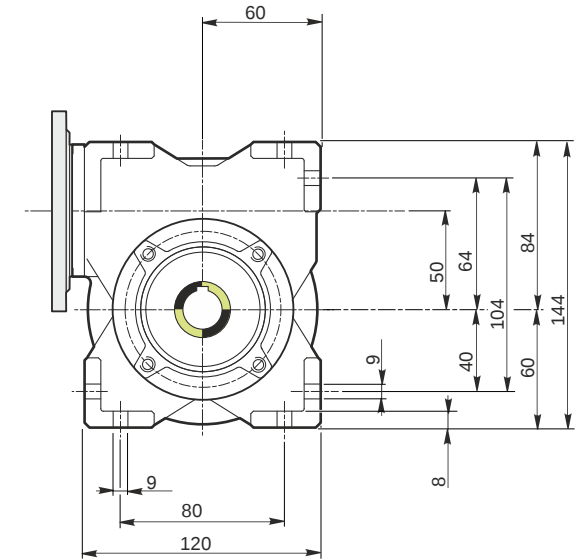
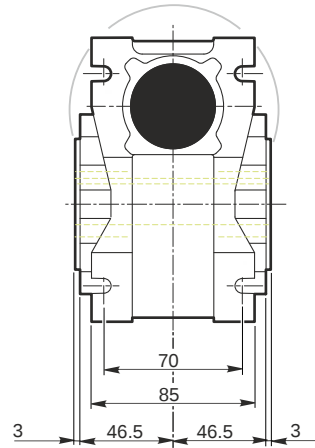
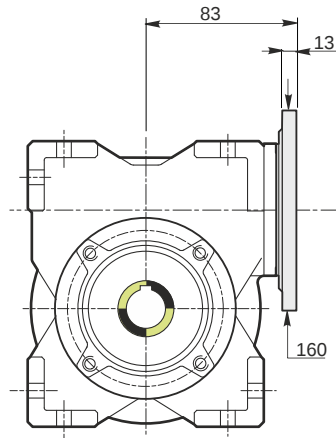

Hollow output shaft

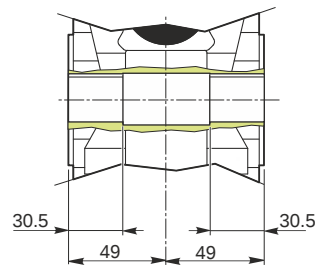
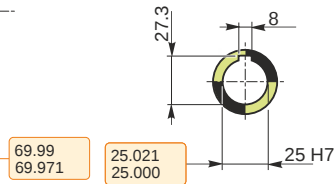

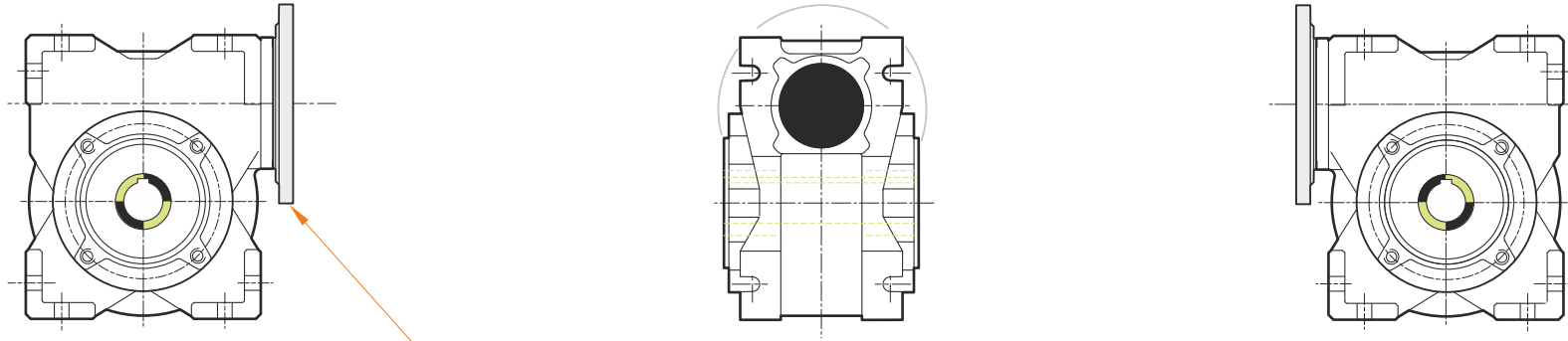

This gear unit is provided with an elastic coupling motor fitting

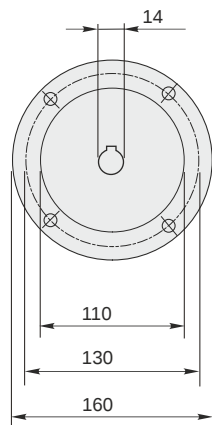

Mounting positions

B3

B6

B7

B8

V5

V6

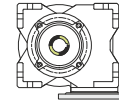
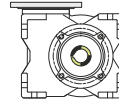
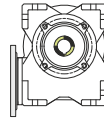
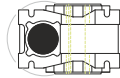
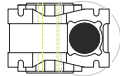
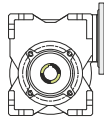

0.13



← Oil quantity [litres]

Lubricant type: Long life synthetic oil ISO VG320

Direction of rotation

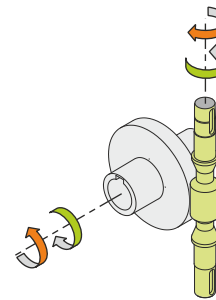
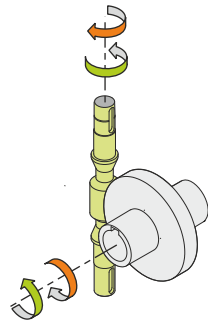
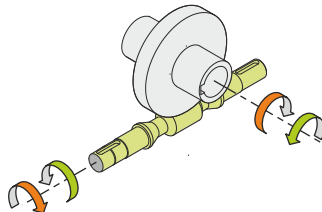

Weight

Gear unit [kg] 3.8

Gearing data

Axial module 2.5
Number of starts 6
Lead angle 30° 57'
Pressure angle 20°

Backdriving

Static back-driving
Quick back-driving
Dynamic back-driving