

### Input data

System of measurement		Metric
Input type		Coupling for electric motor
Input speed	[rpm]	1400
Output speed	[rpm]	280
Ratio (i=)		5
Frequency	[Hz]	50
Input options		IEC
Requested input power	[kW]	0.25
Service factor		10.8
Rated Power P1	[kW]	2.7

### Output data

<b>Gear unit</b>	<b>F RT 50 B3 5 71 B14 AC 25</b>
------------------	----------------------------------

Type		RT - Worm speed reducers
Input type		F (Elastic coupling)
Size		50
Ratio (i=)		5
Input flange		B14
Input speed	[rpm]	1400
Output speed	[rpm]	280
Rated output torque	[Nm]	7.5
Service Factor		10.8
Efficiency		0.88

#### Gear unit configuration

Output shaft		Hollow output shaft
Fixing		Universal
Version		B3

#### Output radial and axial loads

Ball bearings output radial load	[N]	1450
Taper bearings output radial load	[N]	2000
Ball bearings output axial load	[N]	290
Taper bearings output axial load	[N]	400

#### Accessories

Hollow output shaft		AC 25
---------------------	--	-------

#### Electric motor coupling

Size		71 A4
Poles n.		4
Power	[kW]	0.25

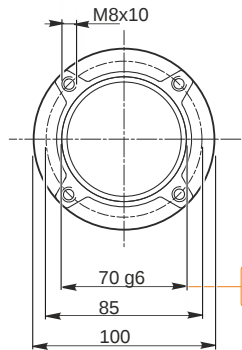
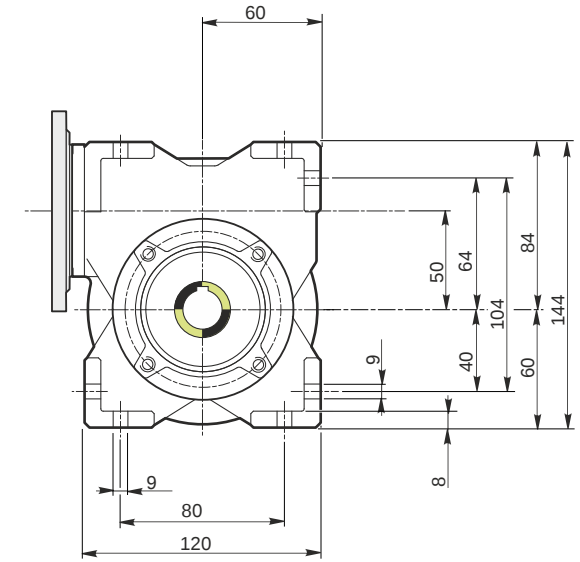
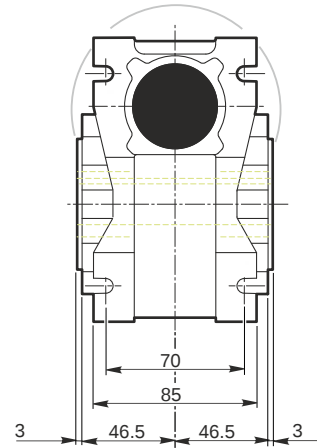
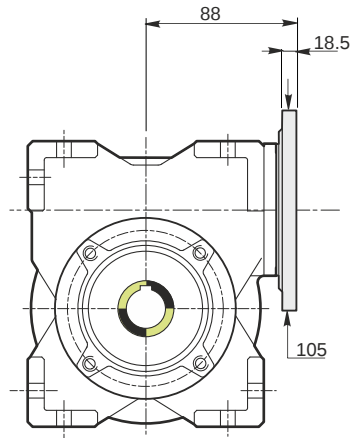

Hollow output shaft

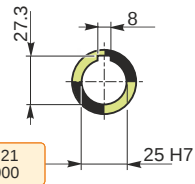

69.99  
69.971

25.021  
25.000

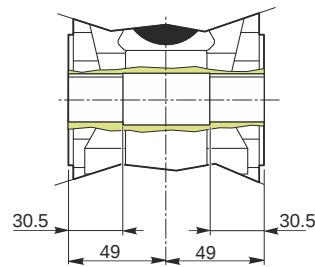

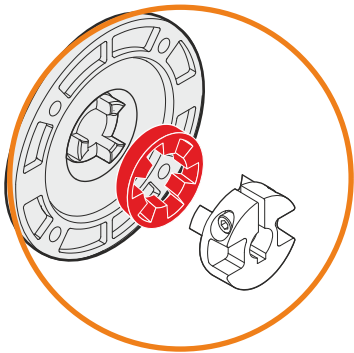
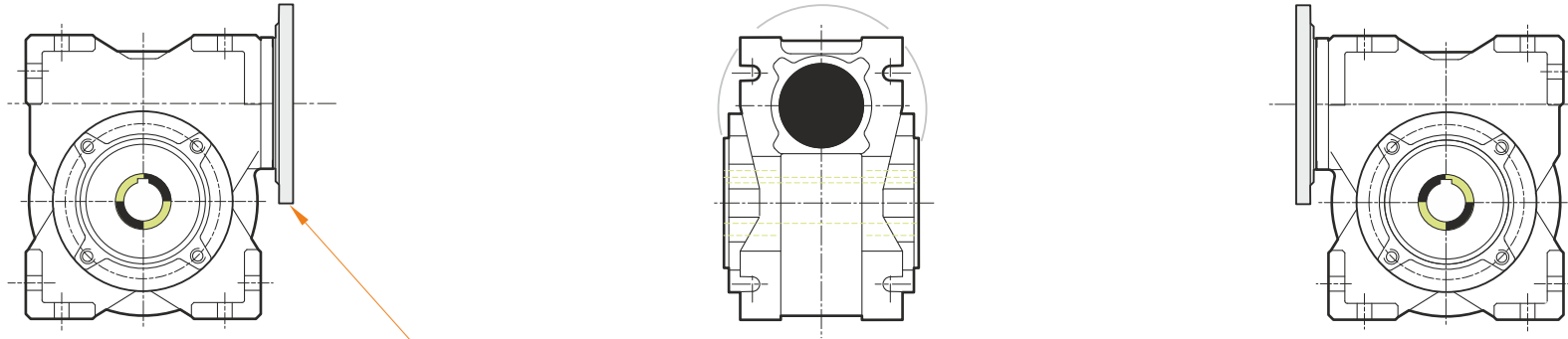

This gear unit is provided with an elastic coupling motor fitting

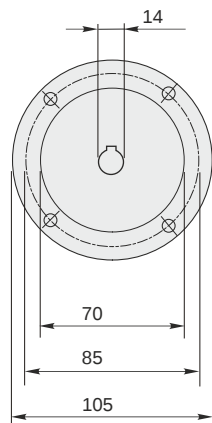

### Mounting positions

B3

B6

B7

B8

V5

V6

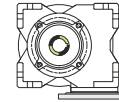
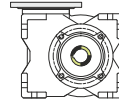
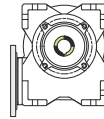
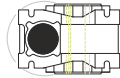
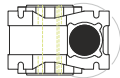
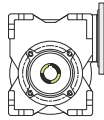

0.13



← Oil quantity [litres]

Lubricant type: Long life synthetic oil ISO VG320

### Direction of rotation

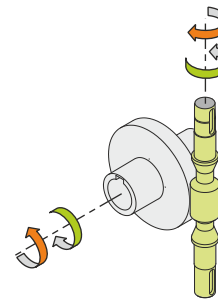
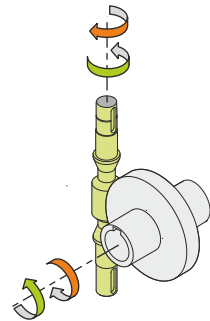
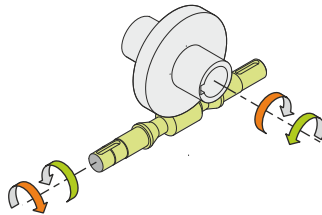
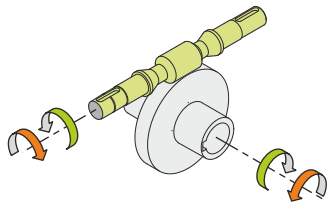

### Weight

Gear unit [kg] 3.8

### Gearing data

Axial module	2.5
Number of starts	6
Lead angle	30° 57'
Pressure angle	20°

### Backdriving

Static back-driving  
Quick back-driving  
Dynamic back-driving