

Input data

System of measurement		Metric
Input type		Coupling for electric motor
Input speed	[rpm]	1400
Output speed	[rpm]	93.33
Ratio (i=)		15
Frequency	[Hz]	50
Input options		IEC
Requested input power	[kW]	0.25
Service factor		6.3
Rated Power P1	[kW]	1.57

Output data

Gear unit	F RT 60 B3 15 71 B5 AC 25
------------------	----------------------------------

Type		RT - Worm speed reducers
Input type		F (Elastic coupling)
Size		60
Ratio (i=)		15
Input flange		B5
Input speed	[rpm]	1400
Output speed	[rpm]	93.33
Rated output torque	[Nm]	20.72
Service Factor		6.3
Efficiency		0.81
Inertia moment	[kgm ²]	0.00011

Gear unit configuration

Output shaft		Hollow output shaft
Fixing		Universal
Version		B3

Output radial and axial loads

Ball bearings output radial load	[N]	2900
Taper bearings output radial load	[N]	3700
Ball bearings output axial load	[N]	580
Taper bearings output axial load	[N]	740

Accessories

Hollow output shaft		AC 25
---------------------	--	-------

Electric motor coupling

Size		71 A4
Poles n.		4
Power	[kW]	0.25

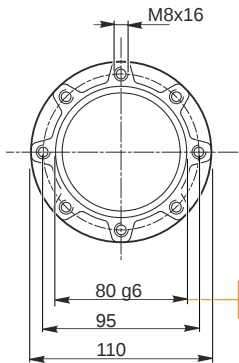
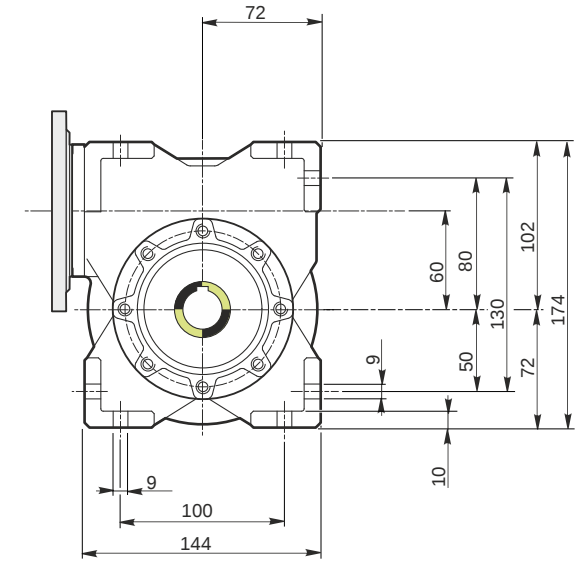
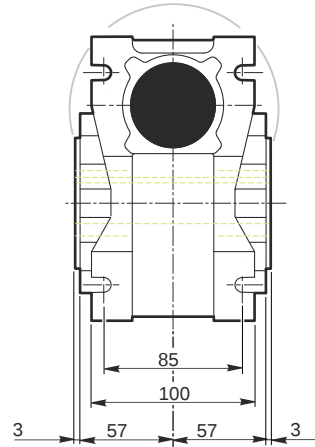
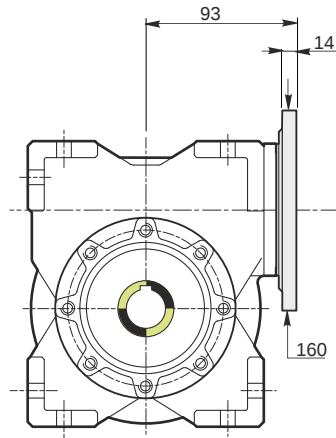

Hollow output shaft

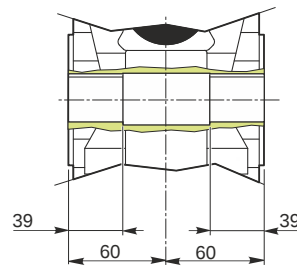
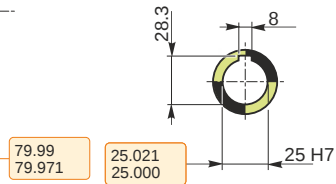

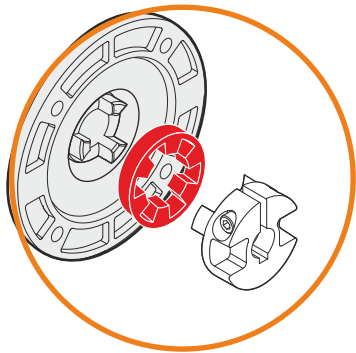
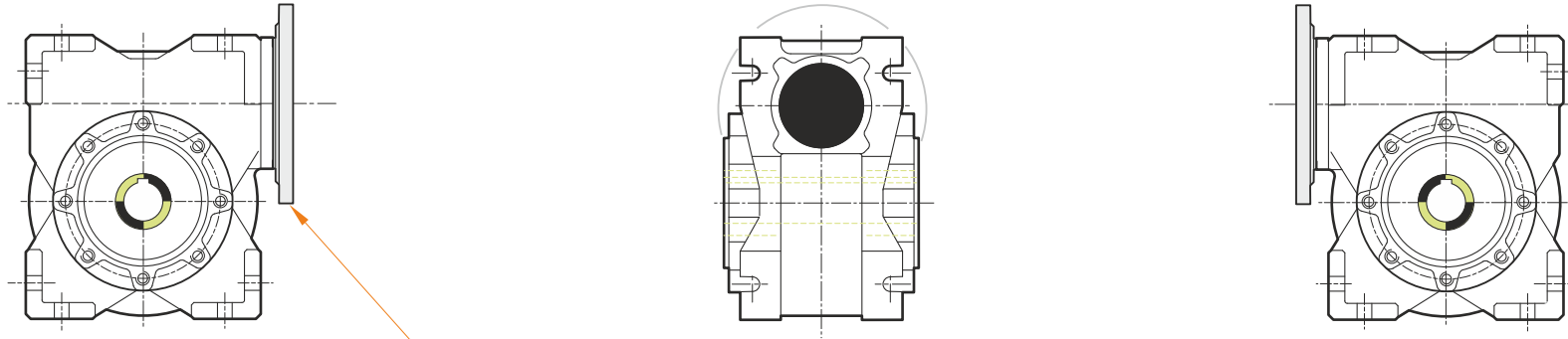

This gear unit is provided with an elastic coupling motor fitting

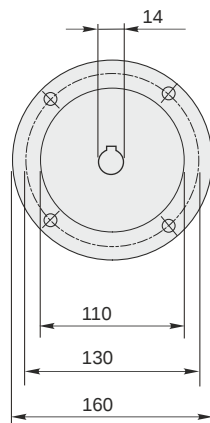

Mounting positions

B3

B6

B7

B8

V5

V6

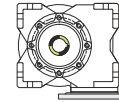
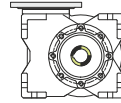
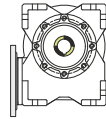
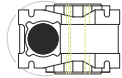
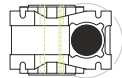
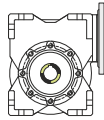

0.23



← Oil quantity [litres]

Lubricant type: Long life synthetic oil ISO VG320

Direction of rotation

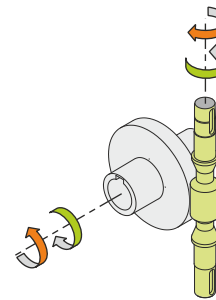
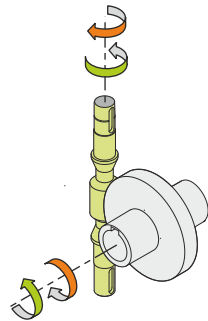
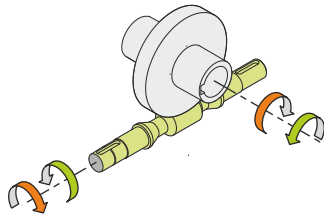
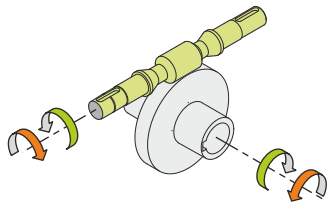

Weight

Gear unit [kg]

6.5

Gearing data

Axial module

3.1

Number of starts

2

Lead angle

12° 55'

Pressure angle

20°

Backdriving

Static back-driving

Quick back-driving

Dynamic back-driving