

### Input data

System of measurement		Metric
Input type		Coupling for electric motor
Input speed	[rpm]	1400
Output speed	[rpm]	93.33
Ratio (i=)		15
Frequency	[Hz]	50
Input options		IEC
Requested input power	[kW]	0.55
Service factor		4
Rated Power P1	[kW]	2.21

### Output data

<b>Gear unit</b>	<b>F RT 70 B3 15 80 B5 AC 28</b>
------------------	----------------------------------

Type		RT - Worm speed reducers
Input type		F (Elastic coupling)
Size		70
Ratio (i=)		15
Input flange		B5
Input speed	[rpm]	1400
Output speed	[rpm]	93.33
Rated output torque	[Nm]	46.71
Service Factor		4
Efficiency		0.83
Inertia moment	[kgm <sup>2</sup> ]	0.000257

#### Gear unit configuration

Output shaft		Hollow output shaft
Fixing		Universal
Version		B3

#### Output radial and axial loads

Ball bearings output radial load	[N]	3600
Taper bearings output radial load	[N]	4500
Ball bearings output axial load	[N]	720
Taper bearings output axial load	[N]	900

#### Accessories

Hollow output shaft		AC 28
---------------------	--	-------

#### Electric motor coupling

Size		80 A4
Poles n.		4
Power	[kW]	0.55

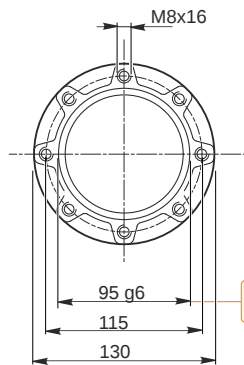
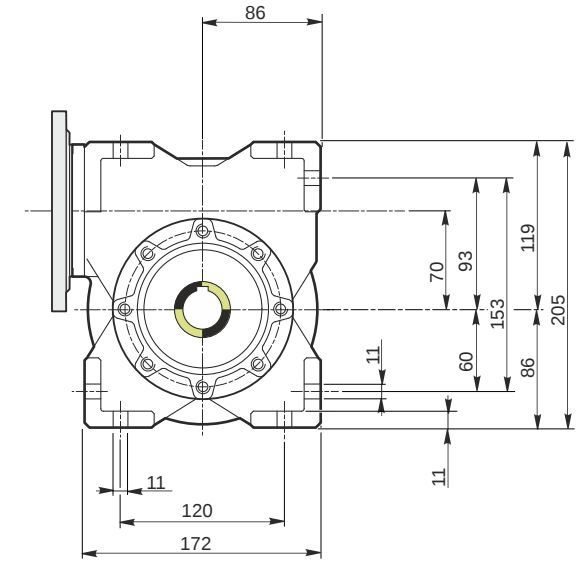
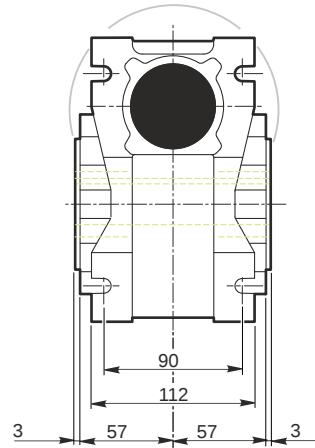
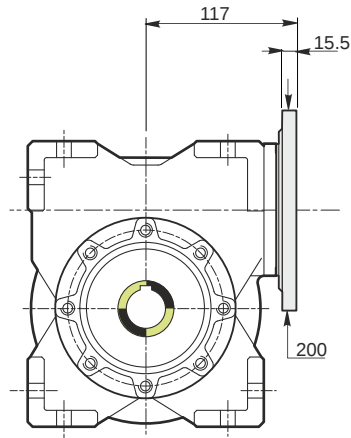

Hollow output shaft

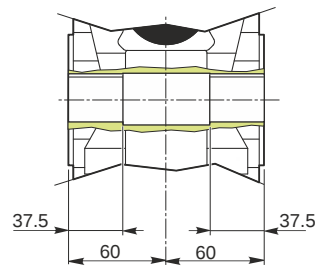
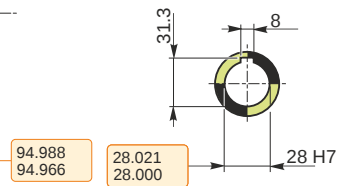

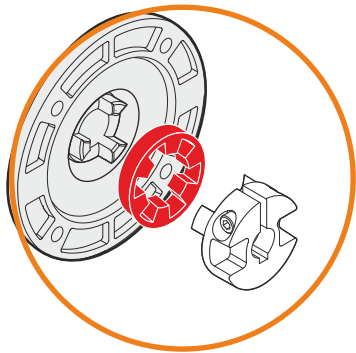
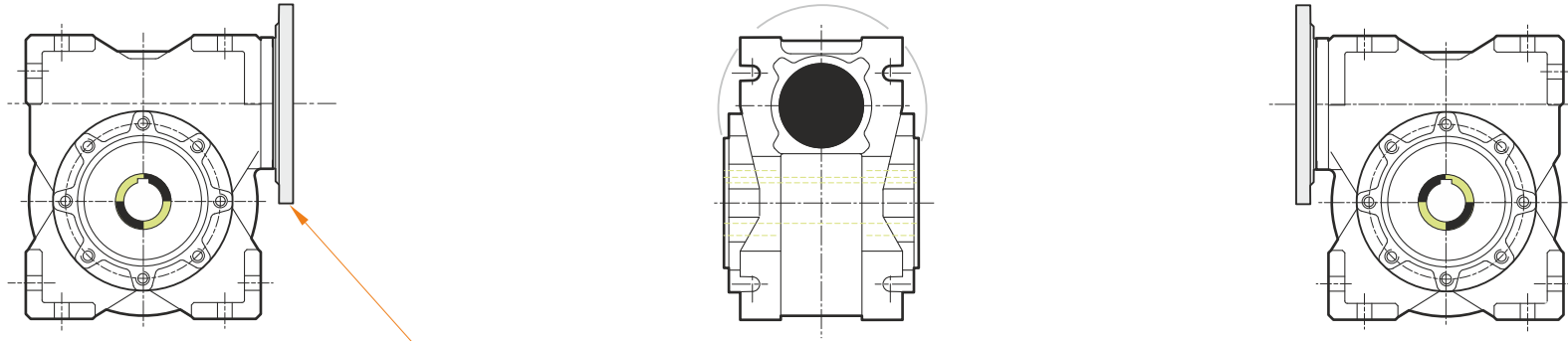

This gear unit is provided with an elastic coupling motor fitting

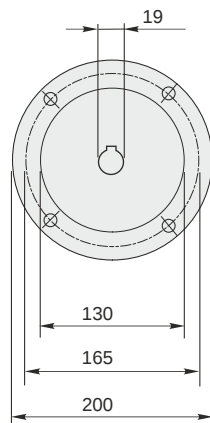

### Mounting positions

B3

B6

B7

B8

V5

V6

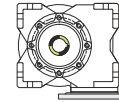
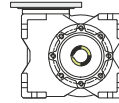
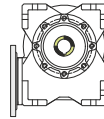
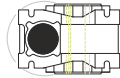
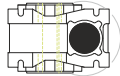
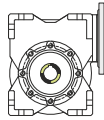

0.35



← Oil quantity [litres]

Lubricant type: Long life synthetic oil ISO VG320

### Direction of rotation

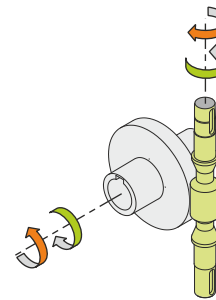
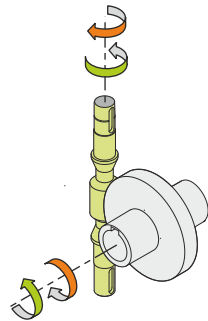
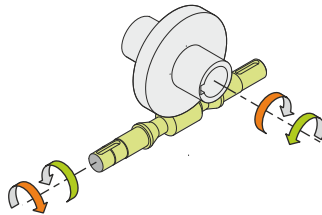
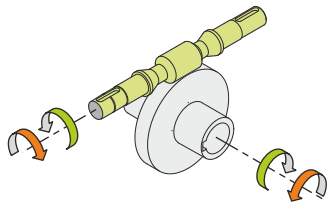

### Weight

Gear unit [kg] 9

### Gearing data

Axial module	3.6
Number of starts	2
Lead angle	12° 40'
Pressure angle	20°

### Backdriving

Static back-driving  
Quick back-driving  
Dynamic back-driving