

Input data

System of measurement		Metric
Input type		Coupling for electric motor
Input speed	[rpm]	1400
Output speed	[rpm]	93.33
Ratio (i=)		15
Frequency	[Hz]	50
Input options		IEC
Requested input power	[kW]	1.1
Service factor		3.1
Rated Power P1	[kW]	3.4

Output data

Gear unit	F RT 85 B3 15 90 B14 AC 35	
------------------	-----------------------------------	--

Type		RT - Worm speed reducers
Input type		F (Elastic coupling)
Size		85
Ratio (i=)		15
Input flange		B14
Input speed	[rpm]	1400
Output speed	[rpm]	93.33
Rated output torque	[Nm]	93.42
Service Factor		3.1
Efficiency		0.83
Inertia moment	[kgm ²]	0.000372

Gear unit configuration

Output shaft		Hollow output shaft
Fixing		Universal
Version		B3

Output radial and axial loads

Ball bearings output radial load	[N]	4400
Taper bearings output radial load	[N]	5500
Ball bearings output axial load	[N]	880
Taper bearings output axial load	[N]	1100

Accessories

Hollow output shaft		AC 35
---------------------	--	-------

Electric motor coupling

Size		90 S4
Poles n.		4
Power	[kW]	1.1

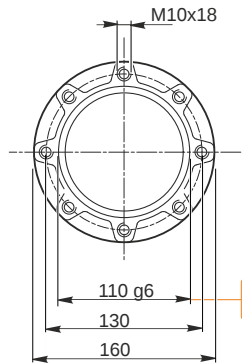
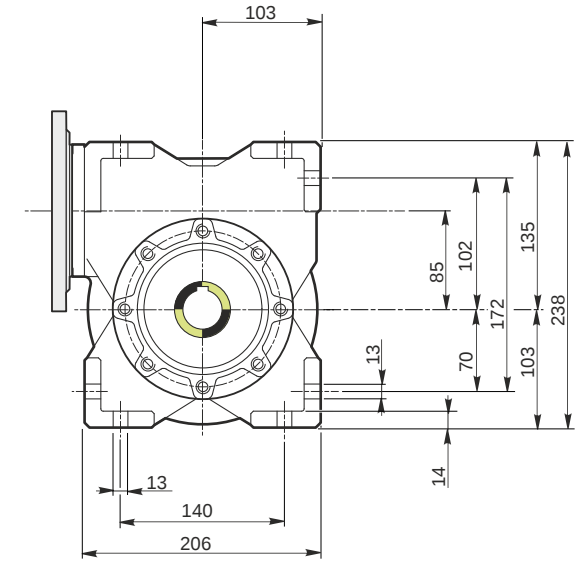
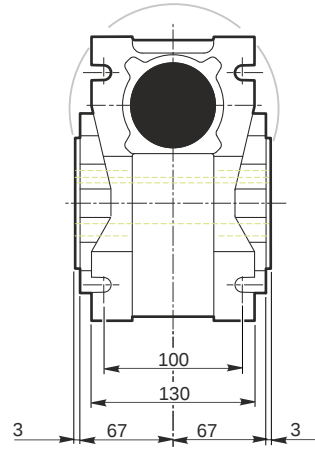
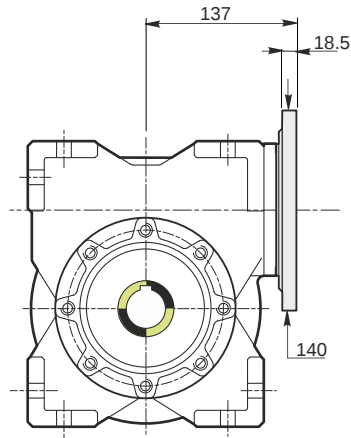

Hollow output shaft

109.988	35.025
109.966	35.000

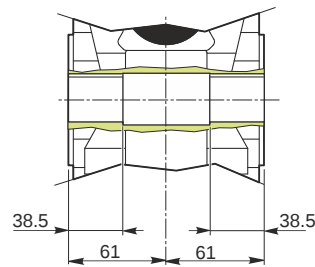
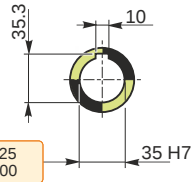

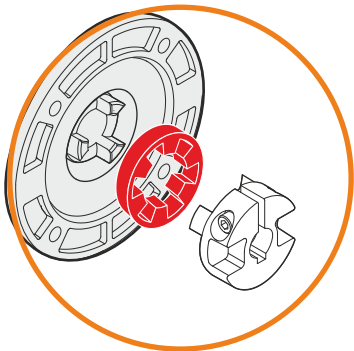
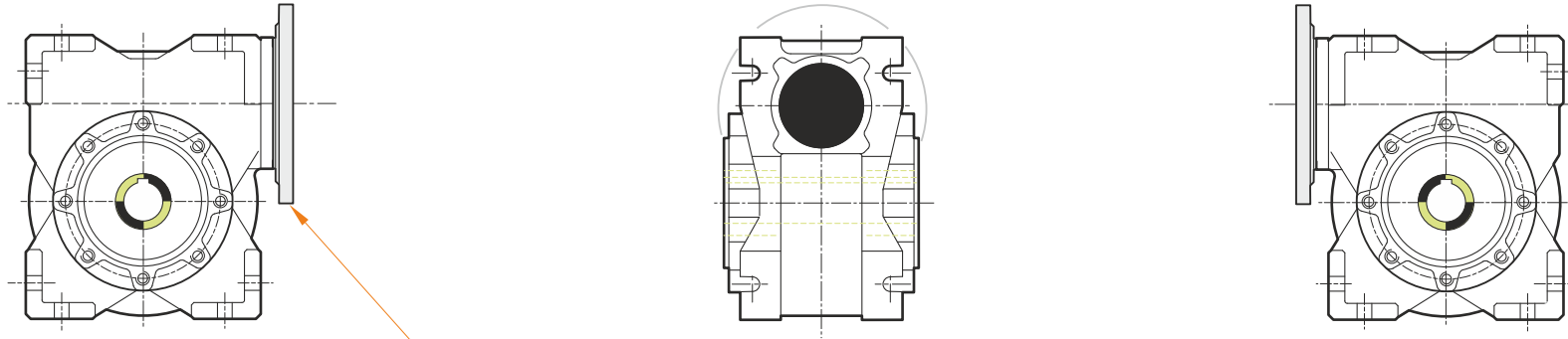

This gear unit is provided with an elastic coupling motor fitting

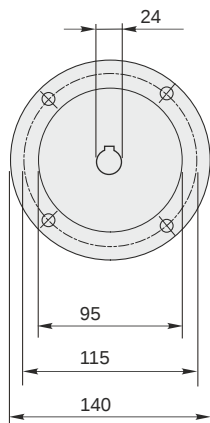

Mounting positions

B3

B6

B7

B8

V5

V6

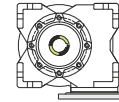
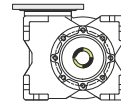
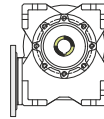
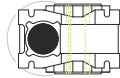
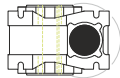
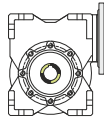

0.6



← Oil quantity [litres]

Lubricant type: Long life synthetic oil ISO VG320

Direction of rotation

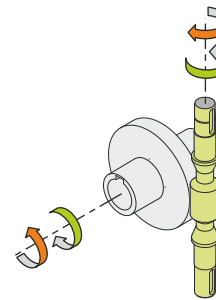
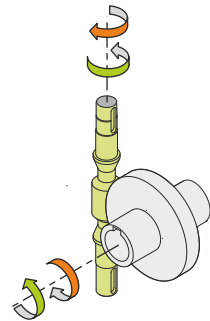
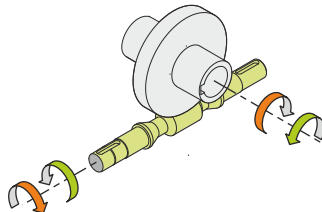
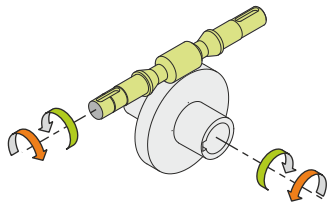

Weight

Gear unit [kg] 13.5

Gearing data

Axial module	4.4
Number of starts	2
Lead angle	13° 02'
Pressure angle	20°

Backdriving

Static back-driving
Quick back-driving
Dynamic back-driving