

### Input data

System of measurement		Metric
Input type		Coupling for electric motor
Input speed	[rpm]	1400
Output speed	[rpm]	93.33
Ratio (i=)		15
Frequency	[Hz]	50
Input options		IEC
Requested input power	[kW]	5.5
Service factor		1.2
Rated Power P1	[kW]	6.52

### Output data

<b>Gear unit</b>	<b>F RT 110 B3 15 132 B5 AC 42</b>
------------------	------------------------------------

Type		RT - Worm speed reducers
Input type		F
Size		110
Ratio (i=)		15
Input flange		B5
Input speed	[rpm]	1400
Output speed	[rpm]	93.33
Rated output torque	[Nm]	472.73
Service Factor		1.2
Efficiency		0.84
Inertia moment	[kgm <sup>2</sup> ]	0.001796

#### Gear unit configuration

Output shaft		Hollow output shaft
Fixing		Universal
Version		B3

#### Output radial and axial loads

Ball bearings output radial load	[N]	5200
Taper bearings output radial load	[N]	6700
Ball bearings output axial load	[N]	1040
Taper bearings output axial load	[N]	1340

#### Accessories

Hollow output shaft		AC 42
---------------------	--	-------

#### Electric motor coupling

Size		132 S4
Poles n.		4
Power	[kW]	5.5

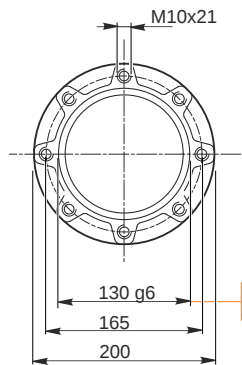
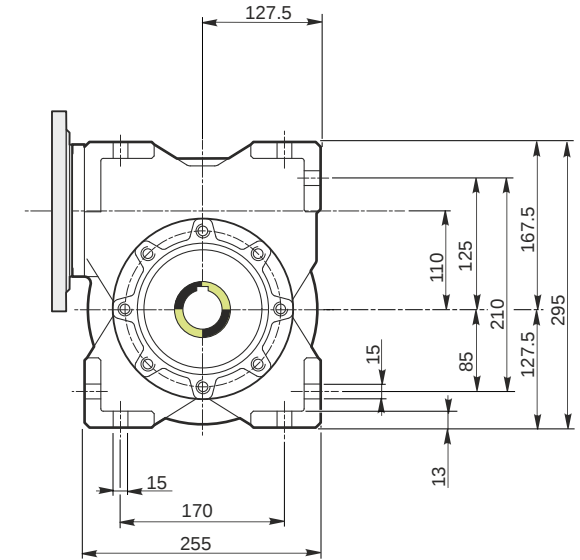
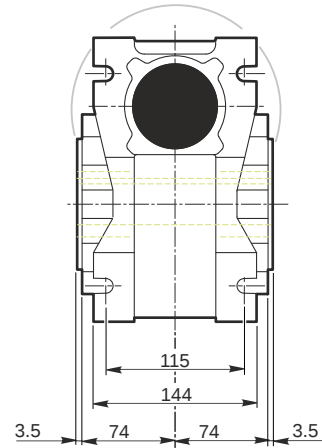
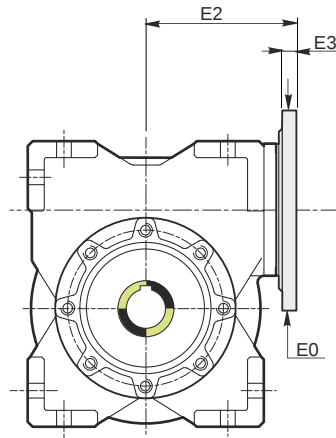

Hollow output shaft

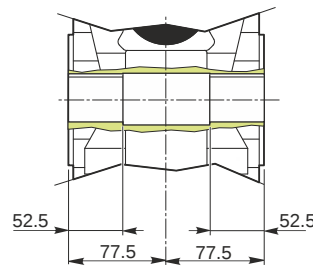
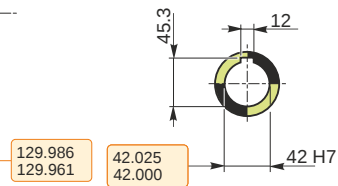

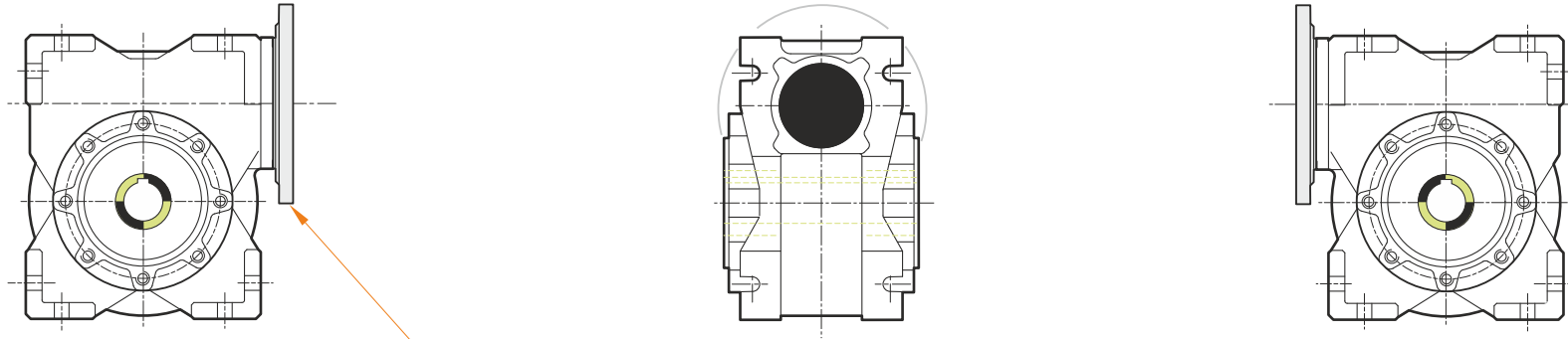

This gear unit is provided with an elastic coupling motor fitting

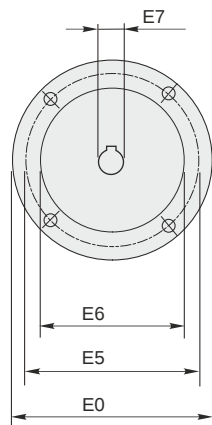

### Mounting positions

B3

B6

B7

B8

V5

V6

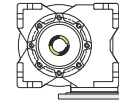
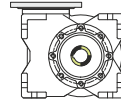
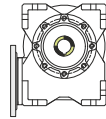
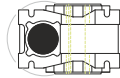
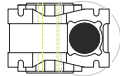
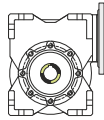

1.5



← Oil quantity [litres]

Lubricant type: Long life synthetic oil ISO VG320

### Direction of rotation

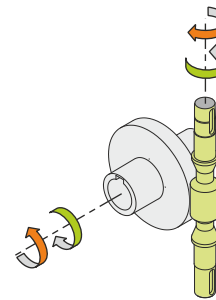
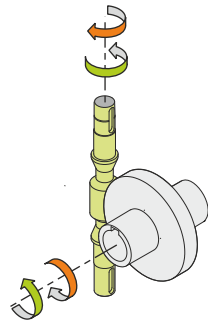
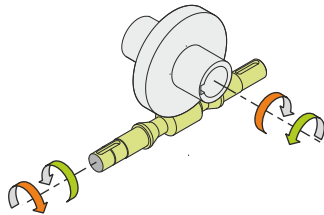

### Weight

Gear unit [kg] 39

### Gearing data

Axial module	5.8
Number of starts	2
Lead angle	14° 09'
Pressure angle	20°

### Backdriving

Static back-driving  
Quick back-driving  
Dynamic back-driving