

Input data

System of measurement		Metric
Input type		Coupling for electric motor
Input speed	[rpm]	1400
Output speed	[rpm]	93.33
Ratio (i=)		15
Frequency	[Hz]	50
Input options		IEC
Requested input power	[kW]	0.06
Service factor		9.2
Rated Power P1	[kW]	0.55

Output data

Gear unit F RS 40 Output flange No Flange FL (bolted) 15 56 B5 AC 19 B3

Type		RS - Worm speed reducers
Input type		F (Elastic coupling)
Size		40
Ratio (i=)		15
Input flange		B5
Mounting position		B3
Input speed	[rpm]	1400
Output speed	[rpm]	93.33
Rated output torque	[Nm]	4.79
Service Factor		9.2
Efficiency		0.78
Inertia moment	[kgm ²]	0.000019

Gear unit configuration

Output shaft		Hollow output shaft
Fixing		Output flange
Right side flange		No Flange
Left side flange		FL (bolted)

Output radial and axial loads

Ball bearings output radial load	[N]	1200
Taper bearings output radial load	[N]	1650
Ball bearings output axial load	[N]	240
Taper bearings output axial load	[N]	330

Accessories

Hollow output shaft		AC 19
---------------------	--	-------

Electric motor coupling

Size		56 A4
Poles n.		4
Power	[kW]	0.06

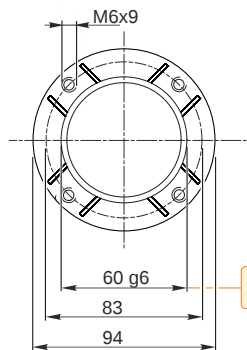
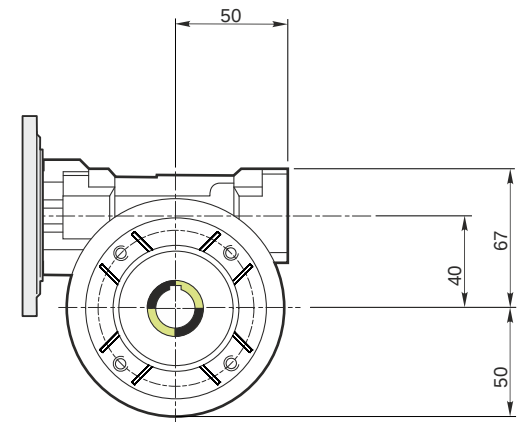
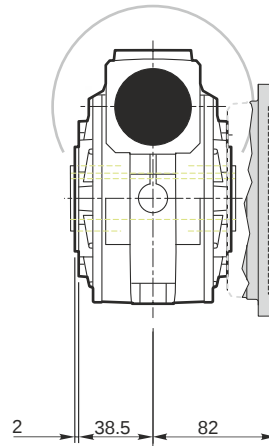
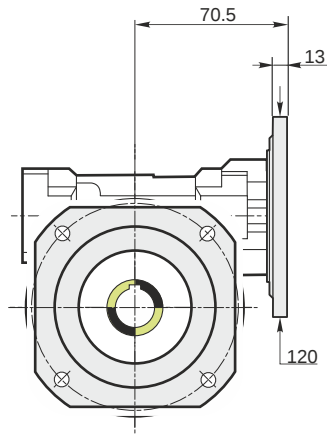

Hollow output shaft

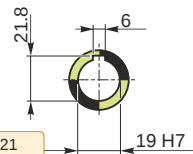

59.99
59.971

19.021
19.000

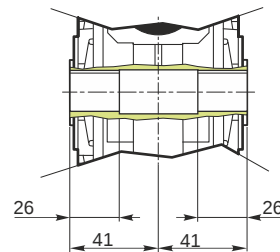

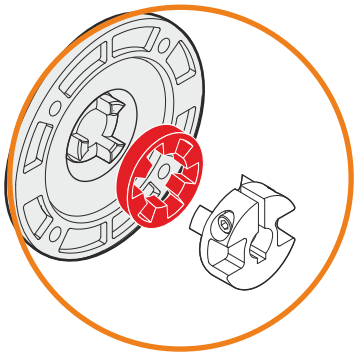
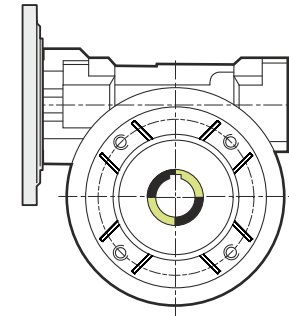
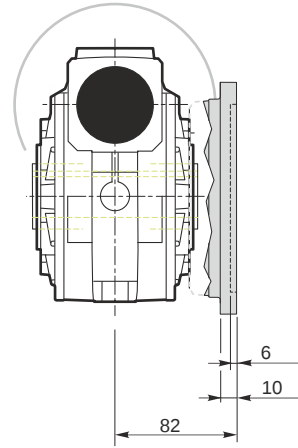
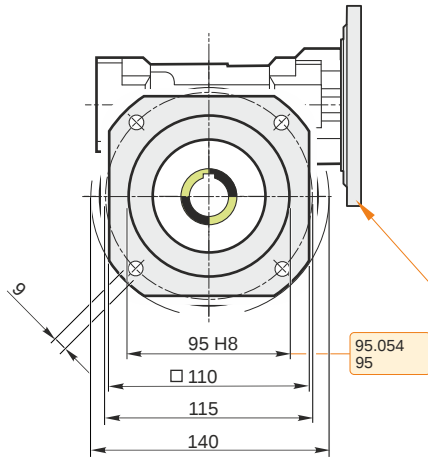

This gear unit is provided with an elastic coupling motor fitting

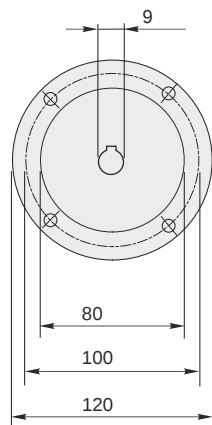

Mounting positions

B3

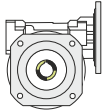

B6



B7

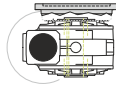

B8

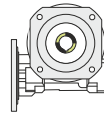

V5

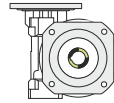

V6

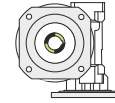

0.08



← Oil quantity [litres]

Lubricant type: Long life synthetic oil ISO VG320

Direction of rotation

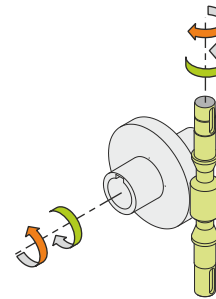
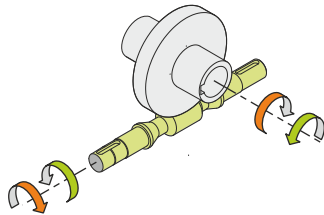

Weight

Gear unit [kg] 2.5

Gearing data

Axial module	2
Number of starts	2
Lead angle	11° 18'
Pressure angle	20°

Backdriving

Variable static self-locking
Quick back-driving in case of vibrations
Dynamic back-driving