

Input data

| | | |
|-----------------------|-------|-----------------------------|
| System of measurement | | Metric |
| Input type | | Coupling for electric motor |
| Input speed | [rpm] | 1400 |
| Output speed | [rpm] | 93.33 |
| Ratio (i=) | | 15 |
| Frequency | [Hz] | 50 |
| Input options | | IEC |
| Requested input power | [kW] | 0.13 |
| Service factor | | 4.2 |
| Rated Power P1 | [kW] | 0.55 |

Output data

Gear unit F RS 40 Output flange No Flange FL (bolted) 15 63 B5 AC 19 B3

| | | |
|---------------------|---------------------|--------------------------|
| Type | | RS - Worm speed reducers |
| Input type | | F (Elastic coupling) |
| Size | | 40 |
| Ratio (i=) | | 15 |
| Input flange | | B5 |
| Mounting position | | B3 |
| Input speed | [rpm] | 1400 |
| Output speed | [rpm] | 93.33 |
| Rated output torque | [Nm] | 10.38 |
| Service Factor | | 4.2 |
| Efficiency | | 0.78 |
| Inertia moment | [kgm ²] | 0.000019 |

Gear unit configuration

| | |
|-------------------|---------------------|
| Output shaft | Hollow output shaft |
| Fixing | Output flange |
| Right side flange | No Flange |
| Left side flange | FL (bolted) |

Output radial and axial loads

| | | |
|-----------------------------------|-----|------|
| Ball bearings output radial load | [N] | 1200 |
| Taper bearings output radial load | [N] | 1650 |
| Ball bearings output axial load | [N] | 240 |
| Taper bearings output axial load | [N] | 330 |

Accessories

| | |
|---------------------|-------|
| Hollow output shaft | AC 19 |
|---------------------|-------|

Electric motor coupling

| | | |
|----------|------|-------|
| Size | | 63 A4 |
| Poles n. | | 4 |
| Power | [kW] | 0.13 |

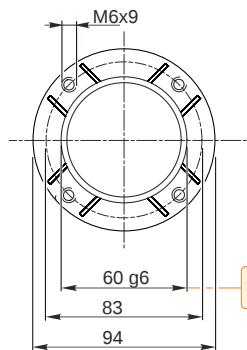
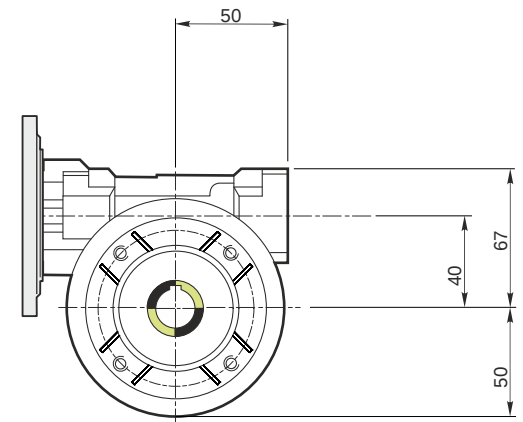
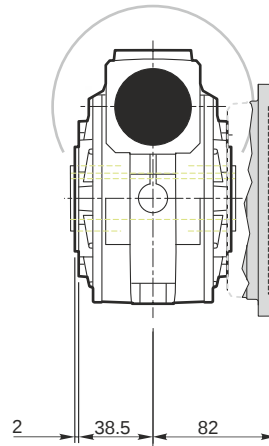
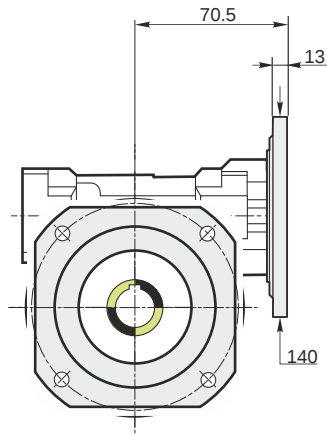

Hollow output shaft

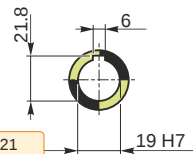

59.99
59.971

19.021
19.000

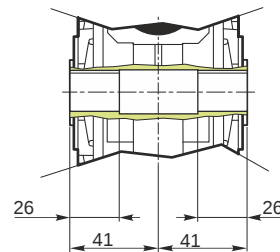

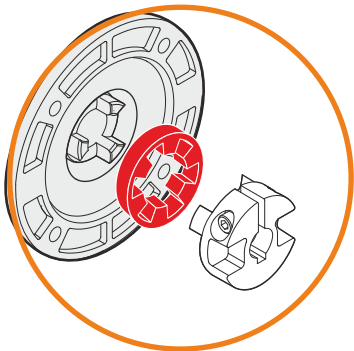
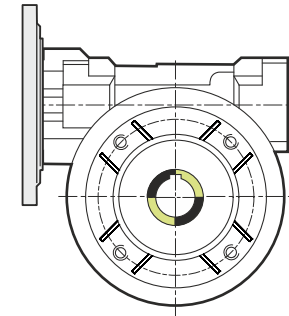
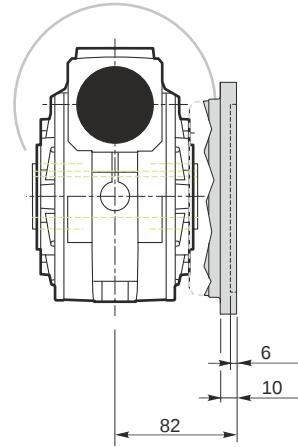
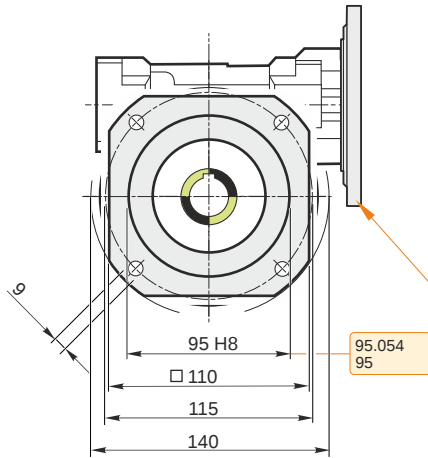

This gear unit is provided with an elastic coupling motor fitting

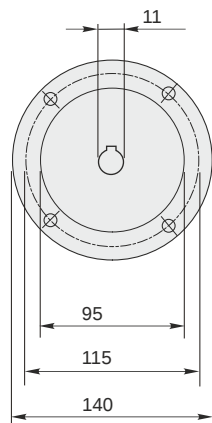

Mounting positions

B3

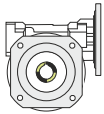

B6

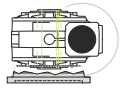

B7

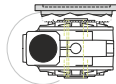

B8

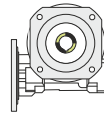

V5

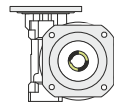

V6

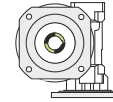

0.08



← Oil quantity [litres]

Lubricant type: Long life synthetic oil ISO VG320

Direction of rotation

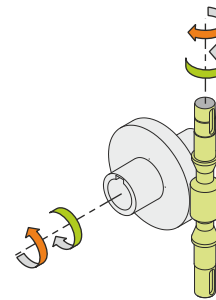
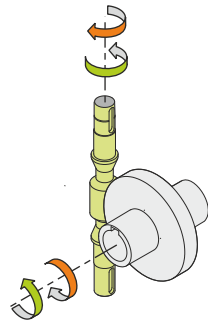
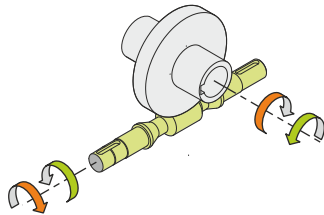
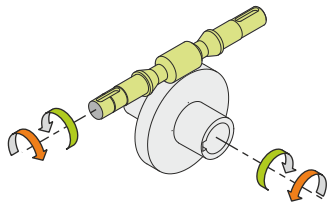

Weight

Gear unit [kg] 2.5

Gearing data

| | |
|------------------|---------|
| Axial module | 2 |
| Number of starts | 2 |
| Lead angle | 11° 18' |
| Pressure angle | 20° |

Backdriving

Variable static self-locking
Quick back-driving in case of vibrations
Dynamic back-driving