

### Input data

System of measurement		Metric
Input type		Coupling for electric motor
Input speed	[rpm]	1400
Output speed	[rpm]	93.33
Ratio (i=)		15
Frequency	[Hz]	50
Input options		IEC
Requested input power	[kW]	0.55
Service factor		1.7
Rated Power P1	[kW]	0.93

### Output data

#### **Gear unit** F RS 50 Output flange No Flange FL (bolted) 15 80 B5 AC 24 B3

Type		RS - Worm speed reducers
Input type		F (Elastic coupling)
Size		50
Ratio (i=)		15
Input flange		B5
Mounting position		B3
Input speed	[rpm]	1400
Output speed	[rpm]	93.33
Rated output torque	[Nm]	43.9
Service Factor		1.7
Efficiency		0.78
Inertia moment	[kgm <sup>2</sup> ]	0.00005

#### **Gear unit configuration**

Output shaft		Hollow output shaft
Fixing		Output flange
Right side flange		No Flange
Left side flange		FL (bolted)

#### **Output radial and axial loads**

Ball bearings output radial load	[N]	1700
Taper bearings output radial load	[N]	2400
Ball bearings output axial load	[N]	340
Taper bearings output axial load	[N]	480

#### **Accessories**

Hollow output shaft		AC 24
---------------------	--	-------

#### **Electric motor coupling**

Size		80 A4
Poles n.		4
Power	[kW]	0.55

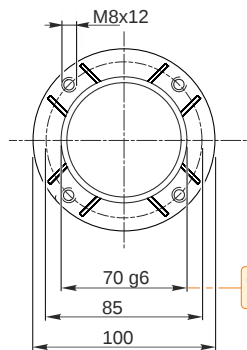
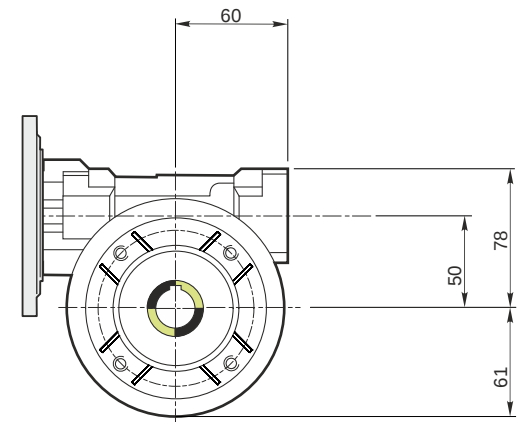
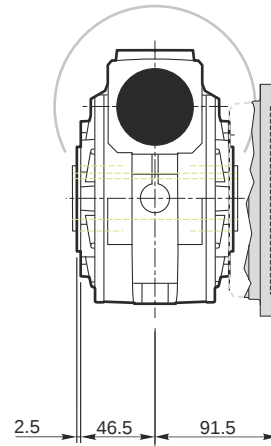
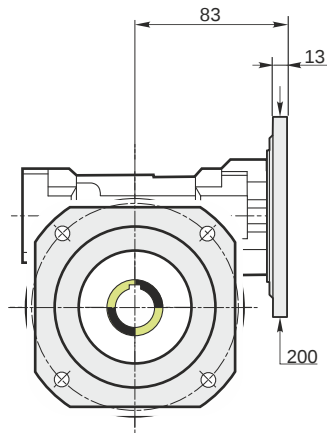

Hollow output shaft

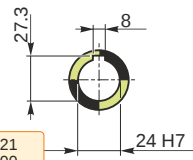

69.99  
69.971

24.021  
24.000

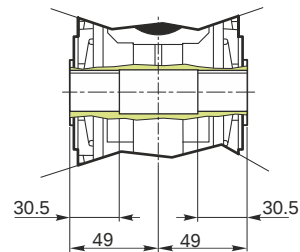

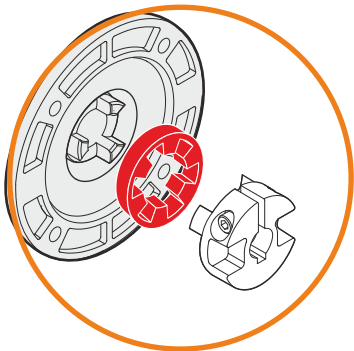
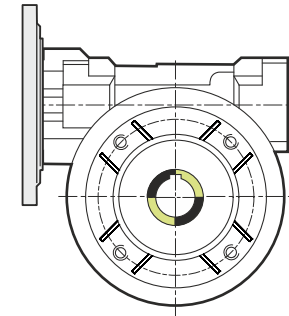
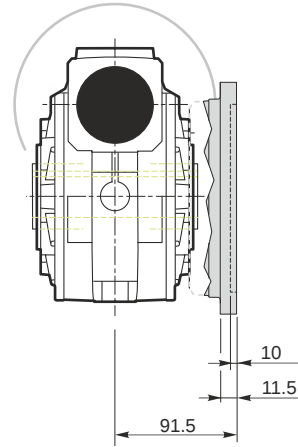
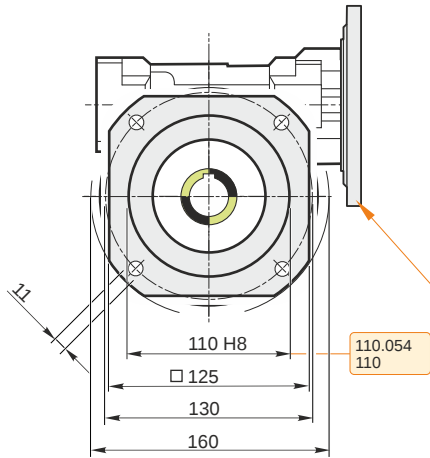

This gear unit is provided with an elastic coupling motor fitting

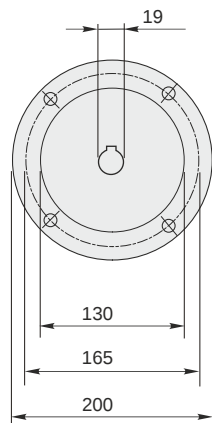

### Mounting positions

B3

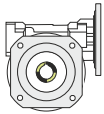

B6

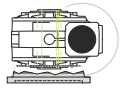

B7

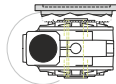

B8

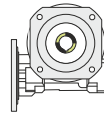

V5

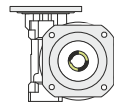

V6

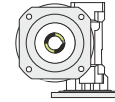

0.13



← Oil quantity [litres]

Lubricant type: Long life synthetic oil ISO VG320

### Direction of rotation

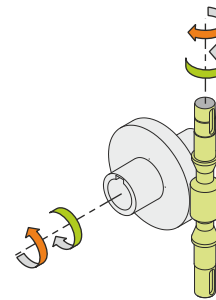
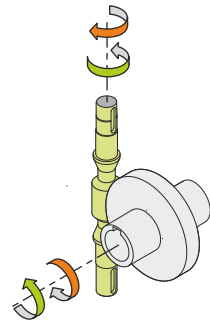
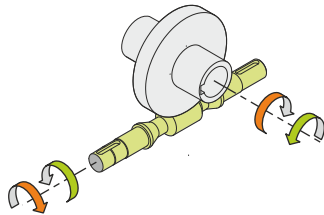
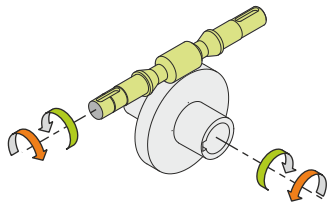

### Weight

Gear unit [kg] 3.8

### Gearing data

Axial module	2.5
Number of starts	2
Lead angle	11° 18'
Pressure angle	20°

### Backdriving

Variable static self-locking  
Quick back-driving in case of vibrations  
Dynamic back-driving