

Input data

System of measurement		Metric
Input type		Coupling for electric motor
Input speed	[rpm]	1400
Output speed	[rpm]	93.33
Ratio (i=)		15
Frequency	[Hz]	50
Input options		IEC
Requested input power	[kW]	0.25
Service factor		3.7
Rated Power P1	[kW]	0.93

Output data

Gear unit	F RS 50 Output flange No Flange FL (bolted) 15 71 B14 AC 24 B3
------------------	---

Type		RS - Worm speed reducers
Input type		F (Elastic coupling)
Size		50
Ratio (i=)		15
Input flange		B14
Mounting position		B3
Input speed	[rpm]	1400
Output speed	[rpm]	93.33
Rated output torque	[Nm]	19.95
Service Factor		3.7
Efficiency		0.78
Inertia moment	[kgm ²]	0.00005

Gear unit configuration

Output shaft	Hollow output shaft
Fixing	Output flange
Right side flange	No Flange
Left side flange	FL (bolted)

Output radial and axial loads

Ball bearings output radial load	[N]	1700
Taper bearings output radial load	[N]	2400
Ball bearings output axial load	[N]	340
Taper bearings output axial load	[N]	480

Accessories

Hollow output shaft	AC 24
---------------------	-------

Electric motor coupling

Size		71 A4
Poles n.		4
Power	[kW]	0.25

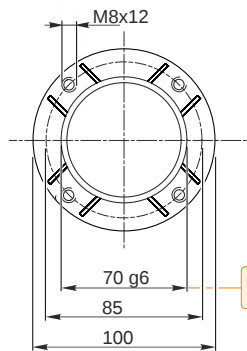
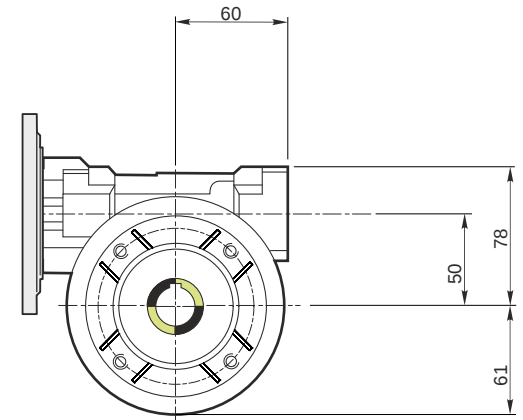
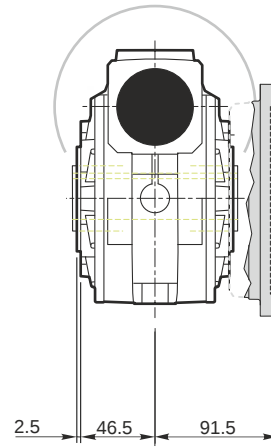
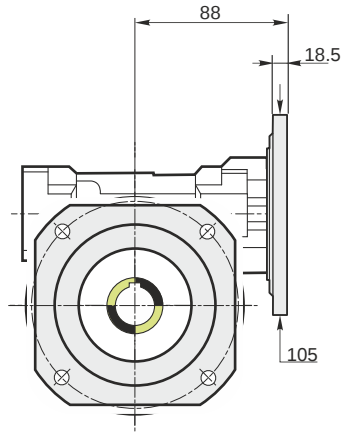

Hollow output shaft

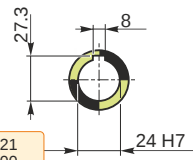

69.99
69.971

24.021
24.000

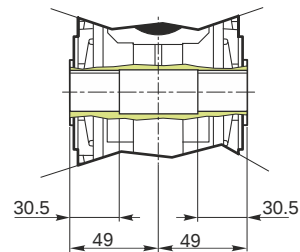

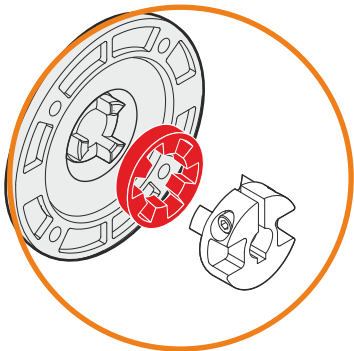
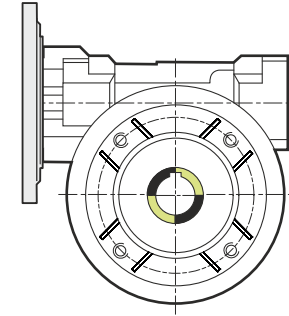
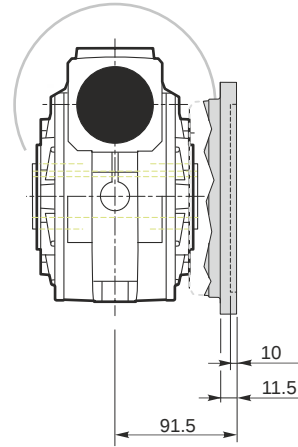
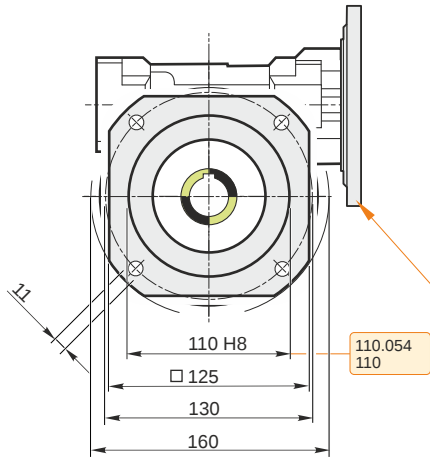

This gear unit is provided with an elastic coupling motor fitting

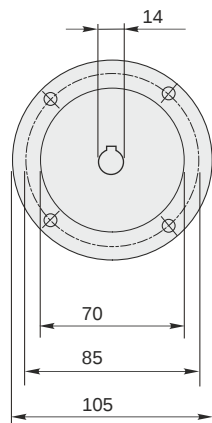

Mounting positions

B3

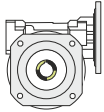

B6

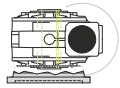

B7

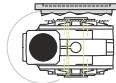

B8

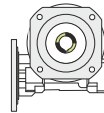

V5

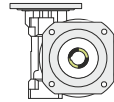

V6

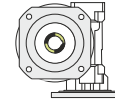

0.13



← Oil quantity [litres]

Lubricant type: Long life synthetic oil ISO VG320

Direction of rotation

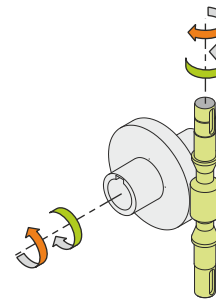
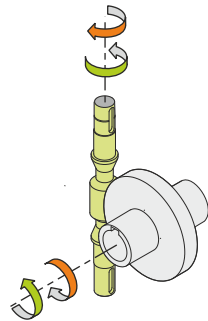
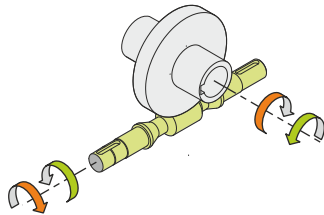
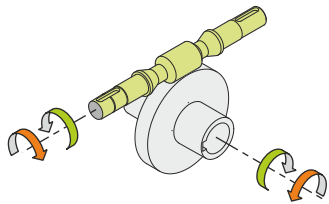

Weight

Gear unit [kg] 3.8

Gearing data

Axial module	2.5
Number of starts	2
Lead angle	11° 18'
Pressure angle	20°

Backdriving

Variable static self-locking
Quick back-driving in case of vibrations
Dynamic back-driving