

### Input data

System of measurement		Metric
Input type		Coupling for electric motor
Input speed	[rpm]	1400
Output speed	[rpm]	93.33
Ratio (i=)		15
Frequency	[Hz]	50
Input options		IEC
Requested input power	[kW]	0.25
Service factor		8.9
Rated Power P1	[kW]	2.21

### Output data

<b>Gear unit</b>	<b>F RS 70 Output flange No Flange FL (bolted) 15 71 B14 AC 30 B3</b>
------------------	---

Type		RS - Worm speed reducers
Input type		F (Elastic coupling)
Size		70
Ratio (i=)		15
Input flange		B14
Mounting position		B3
Input speed	[rpm]	1400
Output speed	[rpm]	93.33
Rated output torque	[Nm]	21.23
Service Factor		8.9
Efficiency		0.83
Inertia moment	[kgm <sup>2</sup> ]	0.000257

#### Gear unit configuration

Output shaft	Hollow output shaft
Fixing	Output flange
Right side flange	No Flange
Left side flange	FL (bolted)

#### Output radial and axial loads

Ball bearings output radial load	[N]	3600
Taper bearings output radial load	[N]	4500
Ball bearings output axial load	[N]	720
Taper bearings output axial load	[N]	900

#### Accessories

Hollow output shaft	AC 30
---------------------	-------

#### Electric motor coupling

Size		71 A4
Poles n.		4
Power	[kW]	0.25

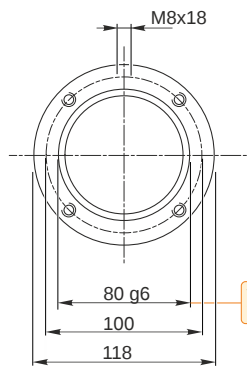
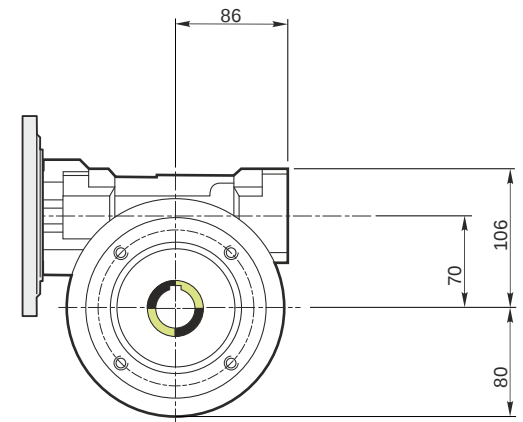
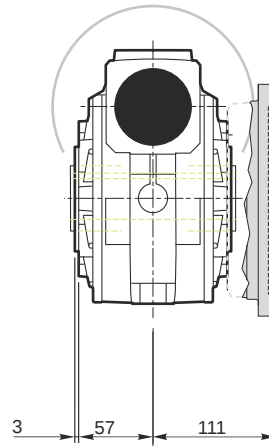
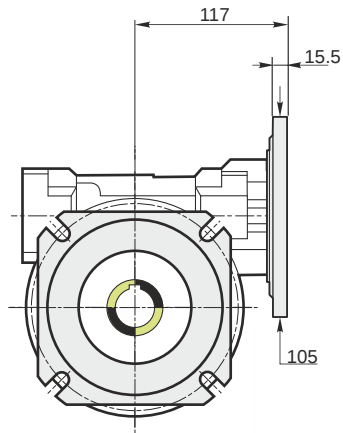

Hollow output shaft

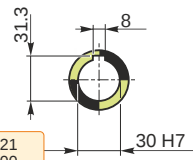

79.99  
79.971

30.021  
30.000

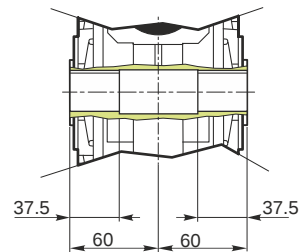

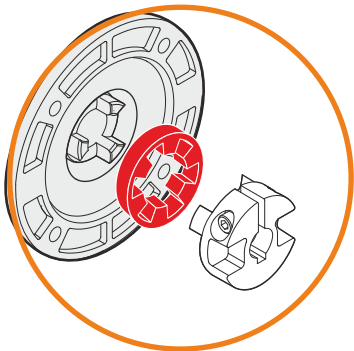
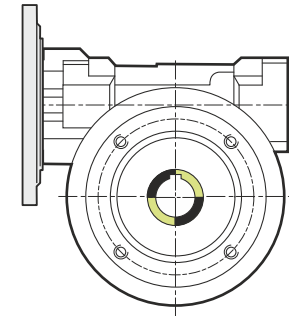
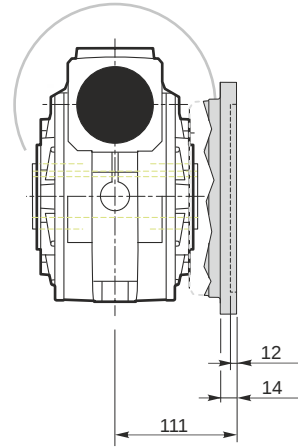
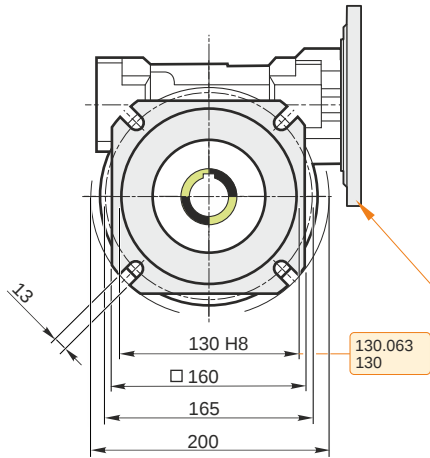

This gear unit is provided with an elastic coupling motor fitting

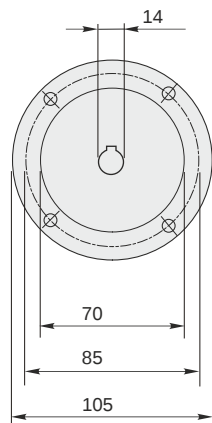

### Mounting positions

B3

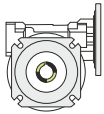

B6

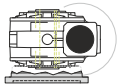

B7

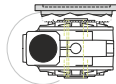

B8

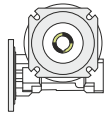

V5

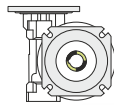

V6

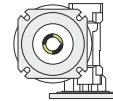

0.35



← Oil quantity [litres]

Lubricant type: Long life synthetic oil ISO VG320

### Direction of rotation

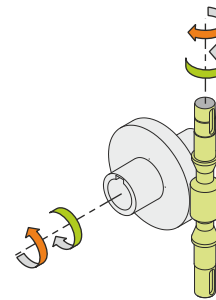
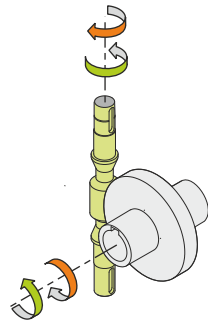
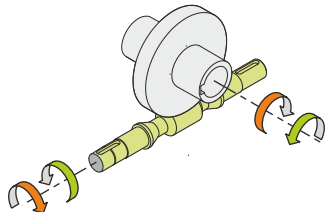
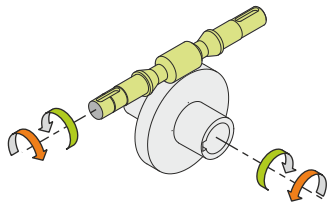

### Weight

Gear unit [kg] 9

### Gearing data

Axial module	3.6
Number of starts	2
Lead angle	12° 40'
Pressure angle	20°

### Backdriving

Static back-driving  
Quick back-driving  
Dynamic back-driving