

### Input data

System of measurement		Metric
Input type		Coupling for electric motor
Input speed	[rpm]	1400
Output speed	[rpm]	93.33
Ratio (i=)		15
Frequency	[Hz]	50
Input options		IEC
Requested input power	[kW]	5.5
Service factor		1.2
Rated Power P1	[kW]	6.52

### Output data

<b>Gear unit</b>	<b>F RS 110 Output flange No Flange FL (bolted) 15 132 B14 AC 42 B3</b>
------------------	---

Type		RS - Worm speed reducers
Input type		F
Size		110
Ratio (i=)		15
Input flange		B14
Mounting position		B3
Input speed	[rpm]	1400
Output speed	[rpm]	93.33
Rated output torque	[Nm]	472.73
Service Factor		1.2
Efficiency		0.84
Inertia moment	[kgm <sup>2</sup> ]	0.001796

#### Gear unit configuration

Output shaft		Hollow output shaft
Fixing		Output flange
Right side flange		No Flange
Left side flange		FL (bolted)

#### Output radial and axial loads

Ball bearings output radial load	[N]	5200
Taper bearings output radial load	[N]	6700
Ball bearings output axial load	[N]	1040
Taper bearings output axial load	[N]	1340

#### Accessories

Hollow output shaft		AC 42
---------------------	--	-------

#### Electric motor coupling

Size		132 S4
Poles n.		4
Power	[kW]	5.5

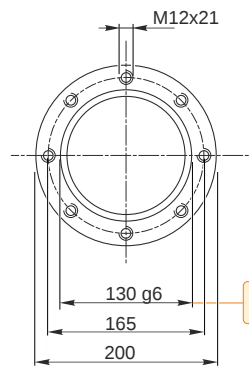
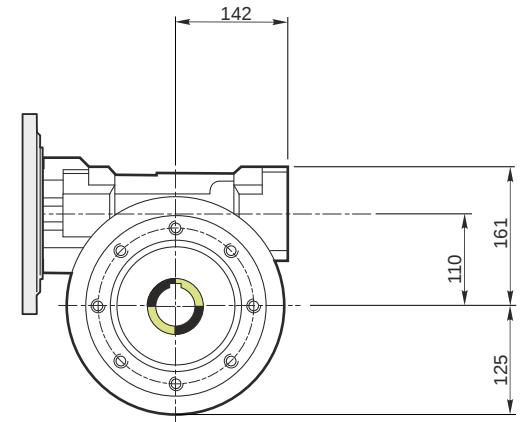
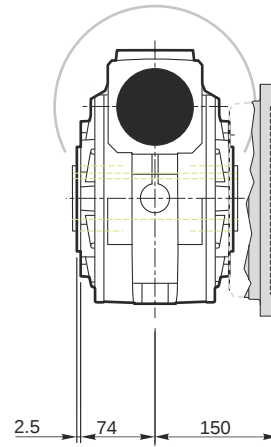
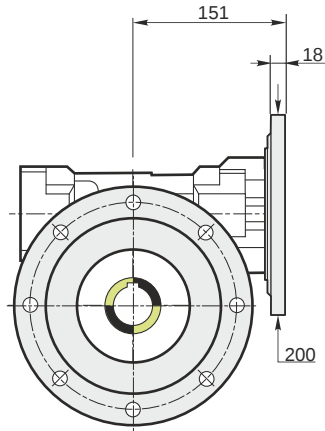

Hollow output shaft

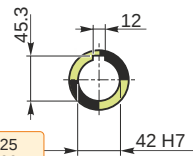

129.986  
129.961

42.025  
42.000

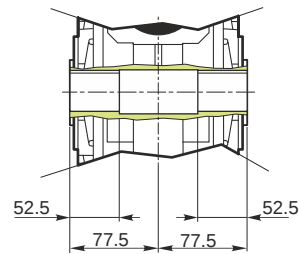

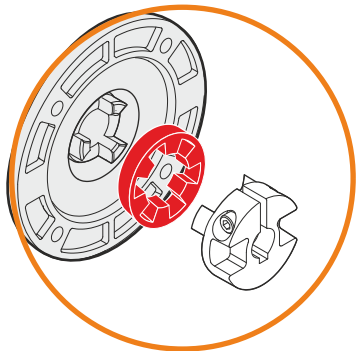
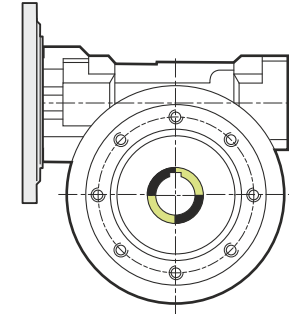
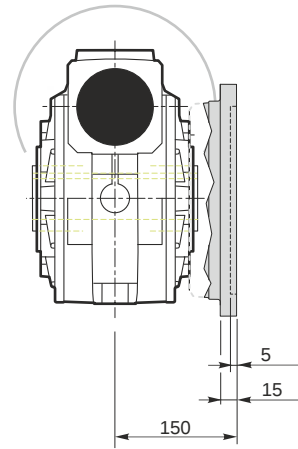
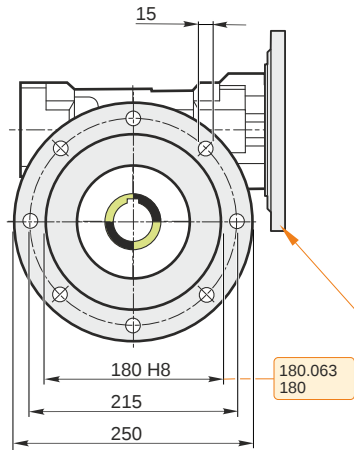

This gear unit is provided with an elastic coupling motor fitting

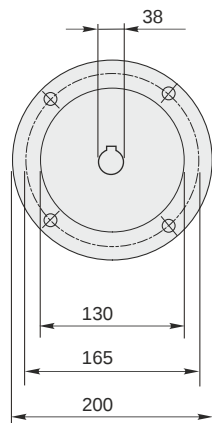

### Mounting positions

B3

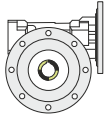

B6

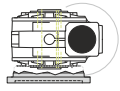

B7

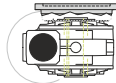

B8

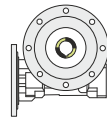

V5

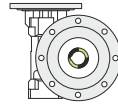

V6

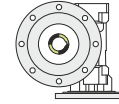

1.5



← Oil quantity [litres]

Lubricant type: Long life synthetic oil ISO VG320

### Direction of rotation

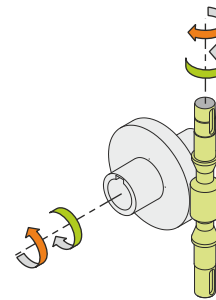
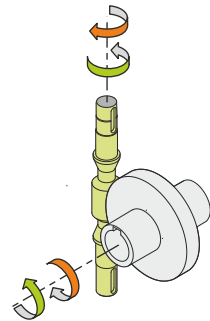
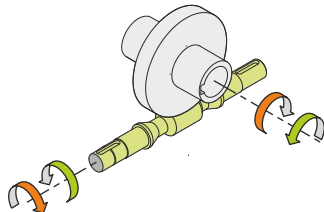
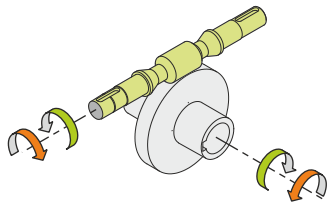

### Weight

Gear unit [kg] 39

### Gearing data

Axial module	5.8
Number of starts	2
Lead angle	14° 09'
Pressure angle	20°

### Backdriving

Static back-driving  
Quick back-driving  
Dynamic back-driving